

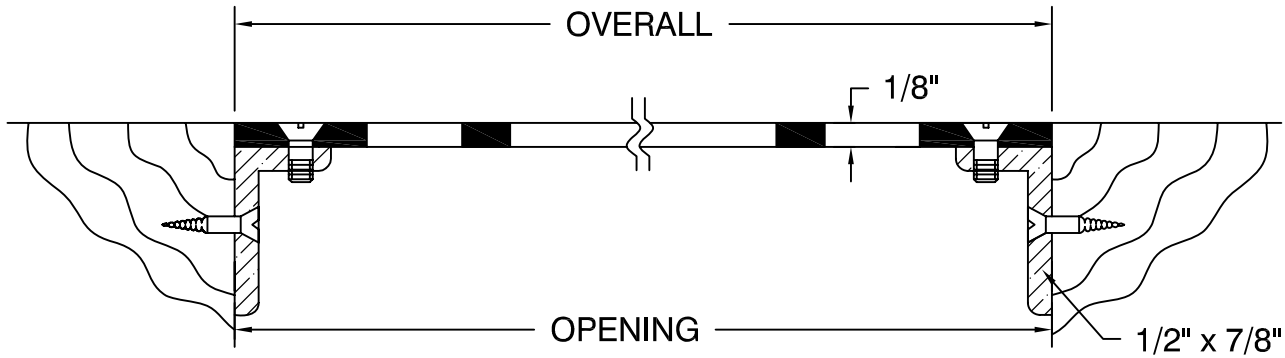

#104 - Decorative perforated grilles applied to angle frames.



REQUIREMENTS			
MATERIAL:			
THICKNESS:			
FINISH:			
MOUNTING:			
		SIZES (Opening)	
QTY	X	Y	
DATE		APPROVED	
-		
JOB # .			
QUOTE #			

	ARCHITECTURAL GRILLE		
	42 SECOND AVENUE BROOKLYN, NY 11215		
CUSTOMER	SIZE	REV	
	A	-	
DESCRIPTION	SCALE	SHEET	
#104 Method of Fastening	1"=1"	1 of 1	

#107A - Angles welded to perforated grilles used as hidden fasteners.

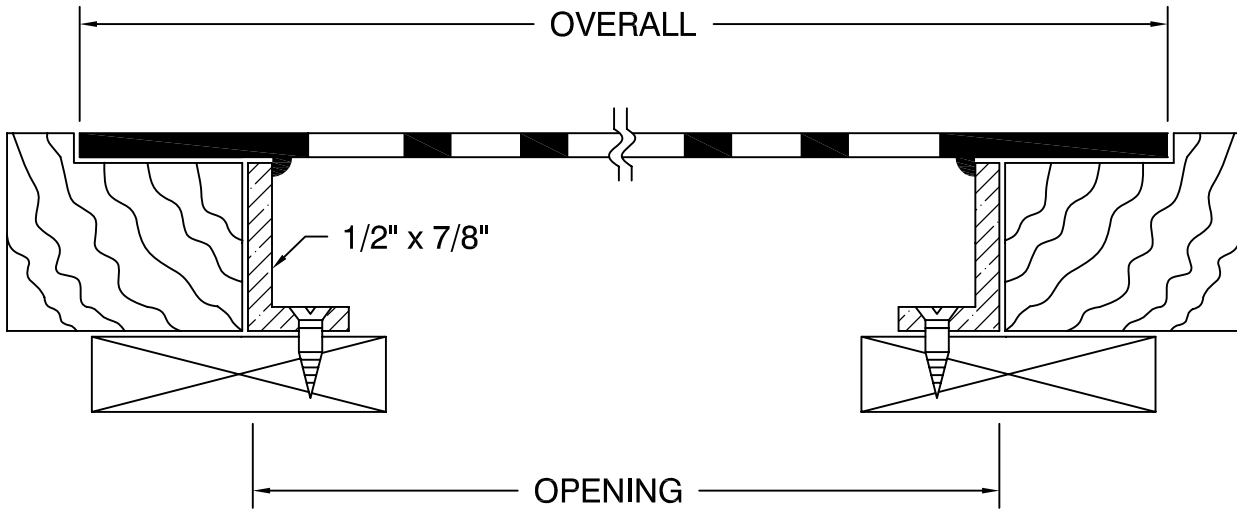

REQUIREMENTS			
MATERIAL:			
THICKNESS:			
FINISH:			
MOUNTING:			
		SIZES (Opening)	
QTY	X	Y	
DATE		APPROVED	
-		
JOB # .			
QUOTE #			

	ARCHITECTURAL GRILLE		
	42 SECOND AVENUE BROOKLYN, NY 11215		
CUSTOMER	SIZE	REV	
	A	-	
DESCRIPTION	SCALE	SHEET	
#107 A Method of Fastening	1"=1"	1 of 1	

#108 - Drop in core using custom 1/2" height AG-10 Core

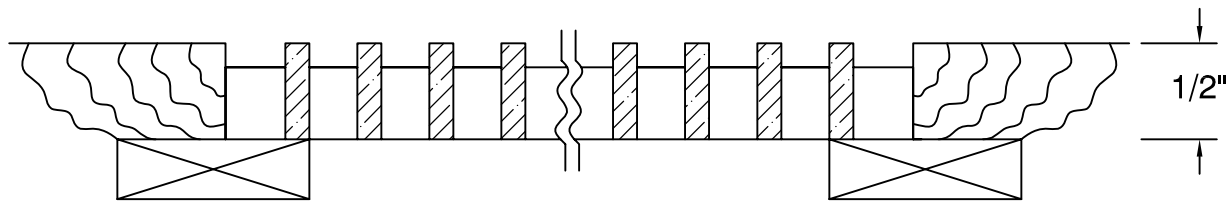

REQUIREMENTS			
MATERIAL:			
THICKNESS: 1/2" depth			
FINISH:			
MOUNTING: CORE			
		SIZES (Opening)	
QTY	X	Y	
DATE		APPROVED	
-		
JOB # .			
QUOTE #			

	ARCHITECTURAL GRILLE		
	42 SECOND AVENUE BROOKLYN, NY 11215		
CUSTOMER	SIZE	REV	
	A	-	
DESCRIPTION	SCALE	SHEET	
#108 Method of Fastening	1"=1"	1 of 1	

#112 - Drop in grille with pre-routed opening for flush mounting using AG10 B frame

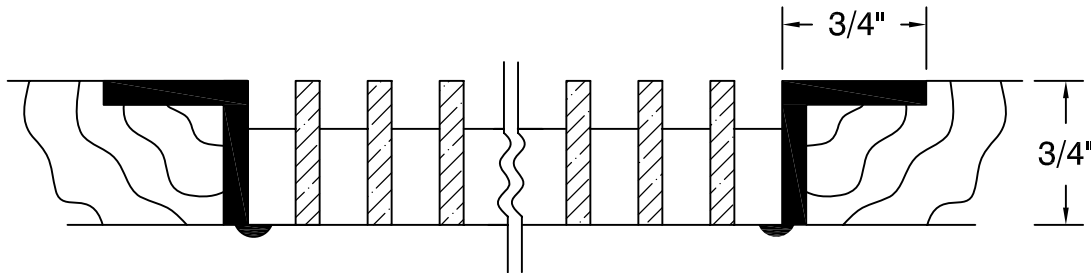

REQUIREMENTS			
MATERIAL:			
THICKNESS: 3/4" depth			
FINISH:			
MOUNTING: B-FRAME			
		SIZES (Opening)	
QTY	X	Y	
DATE		APPROVED	
-		
JOB # .			
QUOTE #			

	ARCHITECTURAL GRILLE		
	42 SECOND AVENUE BROOKLYN, NY 11215		
CUSTOMER	SIZE	REV	
	A	-	
DESCRIPTION	SCALE	SHEET	
#112 Method of Fastening	1"=1"	1 of 1	

#113 - Drop in grille using AG10 B frame in counter top

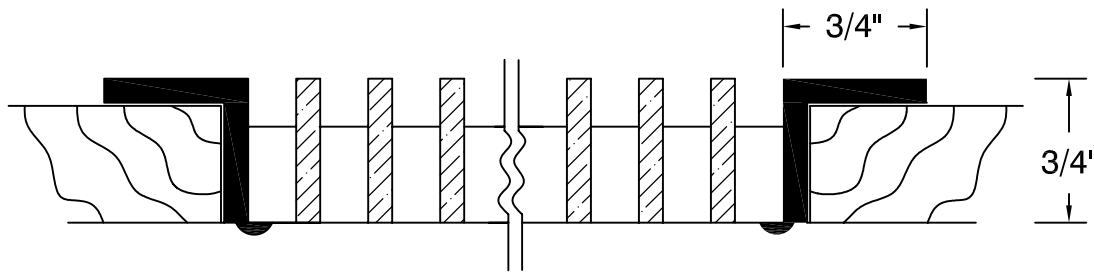

REQUIREMENTS			
MATERIAL:			
THICKNESS: 3/4" depth			
FINISH:			
MOUNTING: B-FRAME			
		SIZES (Opening)	
QTY	X	Y	
1	X	Y	
DATE		APPROVED	
-		
JOB # .			
QUOTE #			

	ARCHITECTURAL GRILLE		
	42 SECOND AVENUE BROOKLYN, NY 11215		
CUSTOMER	SIZE	REV	
	A	-	
DESCRIPTION	SCALE	SHEET	
#113 Method of Fastening	1"=1"	1 of 1	

#115 - Tabs for wall mounting grille cores using 3/4" height AG10 core

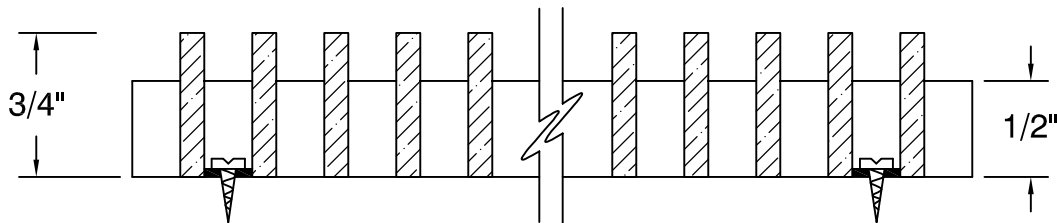

REQUIREMENTS			
MATERIAL:			
THICKNESS: 3/4" depth			
FINISH:			
MOUNTING:			
		SIZES (Opening)	
QTY	X	Y	
DATE		APPROVED	
-		
JOB # .			
QUOTE #			

	ARCHITECTURAL GRILLE		
	42 SECOND AVENUE BROOKLYN, NY 11215		
CUSTOMER	SIZE	REV	
	A	-	
DESCRIPTION	SCALE	SHEET	
#115 Method of Fastening	1"=1"	1 of 1	

METHOD OF FASTENING # 118

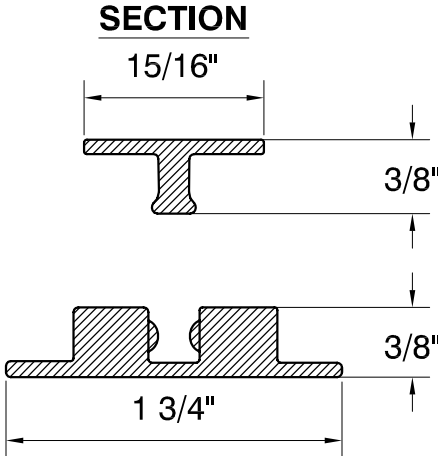

3 D -VIEW

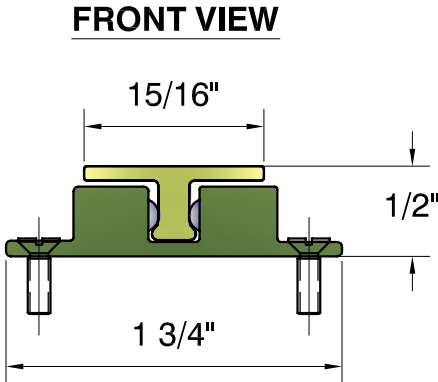
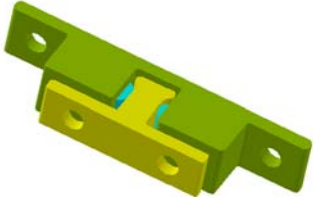

TOP VIEW

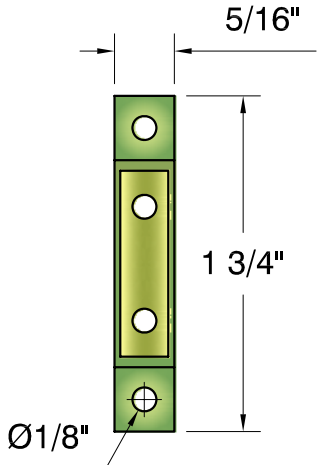

	ARCHITECTURAL GRILLE				
	42 SECOND AVENUE BROOKLYN, NY 11215				
CUSTOMER			Drawn by SB	SIZE A	REV -
DESCRIPTION METHOD OF FASTENING # 118			SCALE 1' = 1'-0"	SHEET 1 OF 1	